

# **Blomberg®**

seit 1883

## **Fridge Freezer** User Manual

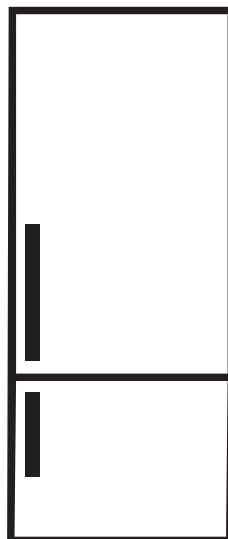

KGM 9681  
KGM 9681 X  
KGM 4681B



## **Please read this manual first!**

Dear Customer,

We hope that your product, which has been produced in a 1st-class manufacturing facility and checked under the most meticulous quality control procedures, will provide you with years of good service.

For this, we recommend you to carefully read the entire manual of your product before using it and keep it at hand for future reference.

## **This manual**

- Will help you use your appliance quickly and safely.
- Read the manual before installing and operating your product.
- Follow the instructions, especially those for safety.
- Keep the manual in an easily accessible place as you may need it later.
- Besides, read also the other documents provided with your product.

Please note that this manual may be valid for other models as well.

## **Symbols and their descriptions**

This instruction manual contains the following symbols:

 Important information or useful usage tips.

 Warning against dangerous conditions for life and property.

 Warning against electric voltage.

---

<b>1 Your refrigerator</b>	<b>4</b>	<b>4 Before operating</b>	<b>15</b>
Electrical Requirements .....	7	Final Check .....	15
Warning! This Appliance Must Be Earthed .....	7	<b>5 Using your refrigerator</b>	<b>16</b>
Energy Saving Tips.....	8	Temperature Control And Adjustment .....	16
Compliance with WEEE Directive and Disposing of the Waste Product: .....	9	Thermostat setting button.....	16
Compliance with RoHS Directive: .....	9	Storing Frozen Food .....	17
Package information.....	9	Freezing Fresh Food .....	17
<b>3 Installation</b>	<b>10</b>	Making Ice Cubes.....	17
Points to be considered when re-transporting your refrigerator .....	10	Defrosting.....	17
Before operating your refrigerator ....	10	Chiller Compartment.....	19
Electric connection .....	10	<b>6 Maintenance and cleaning</b>	<b>20</b>
Disposing of the packaging .....	11	<b>7 Do's and Don'ts</b>	<b>21</b>
Disposing of your old refrigerator ....	11	Problem Solving .....	22
Placing and Installation .....	11	<b>8 Guarantee Details</b>	<b>23</b>
Transportation Instructions.....	12		
Installation Instructions .....	13		
Changing the illumination lamp .....	13		

# 1 Your refrigerator

Congratulations on your choice of a **BLOMBERG** quality Appliance which has been designed to give you service for many years.

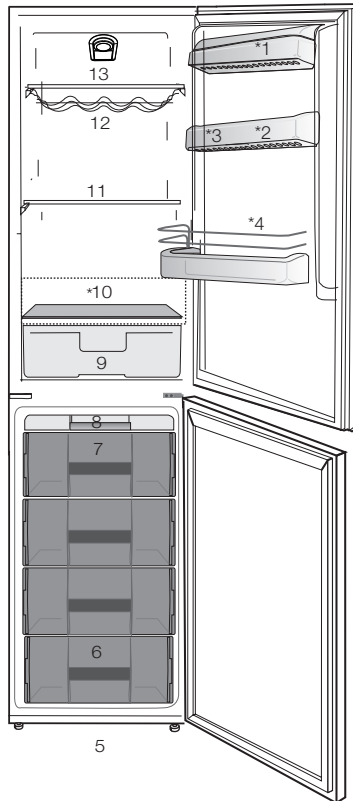

- |                                |                         |
|--------------------------------|-------------------------|
| 1. Butter & Cheese sections    | 8. Ice bank             |
| 2. Door shelves                | 9. Salad crisper        |
| 3. Egg tray                    | 10. Chiller compartment |
| 4. Shelf wire                  | 11. Adjustable shelves  |
| 5. Adjustable feet             | 12. Wine rack           |
| 6. Frozen food storage drawers | 13. Thermostat control  |
| 7. Fast freeze compartment     |                         |

**i\* Optional :** Figures that take place in this instruction manual are schematic and may not correspond exactly with your product. If the subject parts are not included in the product you have purchased, then it is valid for other models.

## 2 Warnings

---

- DO NOT connect your appliance to the electricity supply until all packing and transit protectors have been removed.
- Leave to stand for at least 4 hours before switching on to allow compressor oil to settle if transported horizontally.
- If you are discarding an old refrigerator with a lock or latch fitted to the door, disable the lock/latch, ensure that it is left in a safe condition to prevent the entrapment of young children.
- This appliance must only be used for its intended purpose i.e the storing of edible foodstuff.
- Do not dispose of the appliance on a fire. At **BLOMBERG**, the care and protection of our environment is an ongoing commitment. This appliance which is among the latest range introduced is particularly environment friendly. Your appliance contains non CFC / HFC natural substances in the cooling system (Called R600a) and in the insulation (Called cyclopentane) which are potentially flammable if exposed to fire. Therefore, take care not to damage, the cooling circuit / pipes of the appliance in transportation and in use. In case of damage do not expose the appliance to fire or potential ignition source and immediately ventilate the room where the appliance is situated.
- We suggest you contact your local authority for disposal information and facilities available.
- To obtain the best possible performance and trouble free operation from your appliance it is very important to carefully read these instructions.

- On delivery, check to make sure that the product is not damaged and that all the parts and accessories are in perfect condition.
- Ensure that the plug remains readily accessible. Do not use multiple adapter or extension cable.
- Failure to observe these instructions may invalidate your right to free service during the guarantee period.
- Keep ventilation openings, in the appliance enclosure or in the built-in structure, clear of obstruction.
- Do not use mechanical devices or other means to accelerate the defrosting process, other than those recommended by the manufacturer.
- Do not damage the refrigerant circuit.
- Do not use electrical appliances inside the food storage compartments of the appliance, unless they are of the type recommended by the manufacturer.
- We suggest you keep these instructions in a safe place for easy reference.
- This appliance can be used by children aged from 8 years and above and persons with reduced physical, sensory or mental capabilities or lack of experience and knowledge if they have been given supervision or instruction concerning use of the appliance in a safe way and understand the hazards involved.
- Children should be supervised to ensure that they do not play with the appliance.

## Electrical Requirements

Before you insert the plug into the wall socket make sure that the voltage and the frequency shown on the rating plate inside the appliance corresponds to your electricity supply.

Rating label is on the left hand side of inner liner.

We recommend that this appliance be connected to the mains supply via a suitable switched and fused socket. The appliance must be positioned so that the plug is accessible.

Should the mains lead of the appliance become damaged or should it need

replacing at any time, it must be replaced by a special purpose made mains lead which can only be obtained from a **BLOMBERG** Authorised Service Agent.

## Warning! This Appliance Must Be Earthed

If the fitted moulded plug is not suitable for your socket, then the plug should be cut off and an appropriate plug fitted. Destroy the old plug which is cut off as a plug with bared cord could cause a shock hazard if inserted into a socket elsewhere in the house.

The moulded plug on this appliance incorporates a 13 A fuse. Should the fuse need to be replaced an ASTABEAB approved BS 1362 fuse of the same rating must be used. Do not forget to refit the fuse cover. In the event of losing the fuse cover the plug must not be used until a replacement fuse cover has been fitted. Colour of the replacement fuse cover must be the same colour as that visible on the pin face of the plug. Fuse covers are available from any good electrical store.

## Important! Fitting A Different Plug

As the colours of the wires in the mains lead of this appliance may not correspond with the coloured markings identifying the terminals in your plug proceed as follows: (See diagram).

1. Connect the green-yellow or green (Earth) wire to the terminal in the plug marked 'E' or with the symbol  $\oplus$  or coloured green and yellow or green.
2. Connect the blue (Neutral) wire to the terminal in the plug marked 'N' or coloured black.
3. Connect the brown (Live) wire to the terminal in the plug marked 'L' or coloured red.
4. With alternative plugs a 13 A fuse must be fitted either in the plug or adaptor or in the main fuse box. If in doubt contact a qualified electrician.

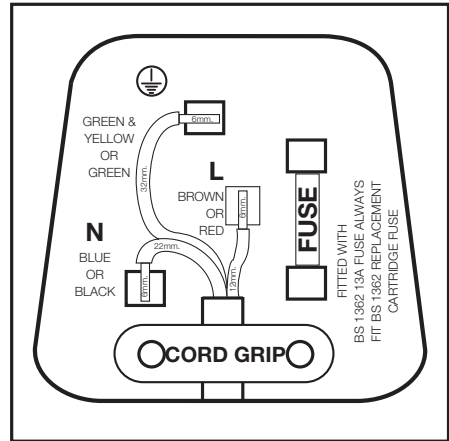

## Energy Saving Tips

1. Ensure your appliance is installed in a well ventilated area.
2. Ensure the time between buying chilled/frozen food and placing them in your appliance is kept at minimum, particularly in summer. We recommend you use a cool bag or a special carrier bag to carry perishable food.
3. Do not leave the door (s) of your appliance open longer than necessary and ensure they are closed properly after each opening.



4. Defrost frozen food in the fridge, so that frozen food acts as an ice pack to assist cooling in fridge.

### **Compliance with WEEE Directive and Disposing of the Waste Product:**

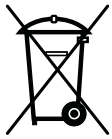

This product complies with EU WEEE Directive (2012/19/EU).

This product bears a classification symbol for waste electrical and electronic equipment (WEEE). This product has been manufactured with high quality parts and materials which can be reused and are suitable for recycling. Do not dispose of the waste product with normal domestic and other wastes at the end of its service life. Take it to the collection center for the recycling of electrical and electronic equipment. Please consult your local authorities to learn about these collection centers.

### **Compliance with RoHS Directive:**

The product you have purchased complies with EU RoHS Directive (2011/65/EU). It does not contain harmful and prohibited materials specified in the Directive.

### **Package information**

Packaging materials of the product are manufactured from recyclable materials in accordance with our National Environment Regulations. Do not dispose of the packaging materials together with the domestic or other wastes. Take them to the packaging material collection points designated by the local authorities.

### 3 Installation

⚠ Please remember that the manufacturer shall not be held liable if the information given in the instruction manual is not observed.

#### Points to be considered when re-transporting your refrigerator

1. Your refrigerator must be emptied and cleaned prior to any transportation.
2. Shelves, accessories, crisper and etc. in your refrigerator must be fastened securely by adhesive tape against any jolt before repackaging.
3. Packaging must be must be adequate and the rules of transportation printed on the package must be followed.

Please do not forget...

Every recycled material is an indispensable source for the nature and for our national resources.

If you wish to contribute to recycling the packaging materials, you can get further information from the environmental bodies or local authorities.

#### Before operating your refrigerator

Before starting to use your refrigerator check the following:

1. Is the interior of the refrigerator dry and can the air circulate freely in the rear of it?
2. Please install the 2 plastic wedges as illustrated in the figure. Plastic wedges will provide the required distance between your refrigerator and the wall in order to

allow the air circulation. (The illustrated figure is only an example and does not match exactly with your product.)

3. Clean the interior of the refrigerator as recommended in the "Maintenance and cleaning" section.
4. Plug the refrigerator into the wall outlet. When the fridge door is open, the fridge compartment interior light will come on.
5. You will hear a noise as the compressor starts up. The liquid and gases sealed within the refrigeration system may also give rise to noise, even if the compressor is not running and this is quite normal.
6. Front edges of the refrigerator may feel warm. This is normal. These areas are designed to be warm to avoid condensation

#### Electric connection

Connect your product to a grounded socket which is being protected by a fuse with the appropriate capacity.

Important:

- The connection must be in compliance with national regulations.
- The power cable plug must be easily accessible after installation.
- The specified voltage must be equal to your mains voltage.
- Extension cables and multiway plugs must not be used for connection.

⚠ A damaged power cable must be replaced by a qualified electrician.

⚠ Product must not be operated before it is repaired! There is danger of electric shock!

## Disposing of the packaging

The packing materials may be dangerous for children. Keep the packing materials out of the reach of children or dispose of them by classifying them in accordance with the waste instructions. Do not dispose of them along with the normal household waste.

The packing of your refrigerator is produced from recyclable materials.

## Disposing of your old refrigerator

Dispose of your old refrigerator without giving any harm to the environment.

- You may consult your authorised dealer or waste collection center of your municipality about the disposal of your refrigerator.

Before disposing of your refrigerator, cut out the electric plug and, if there are any locks on the door, make them inoperable in order to protect children against any danger.

## Placing and Installation

⚠ If the entrance door of the room where the refrigerator will be installed is not wide enough for the refrigerator to pass through, then carefully remove the doors of your refrigerator and pass it sideways through the door.

1. Install your refrigerator to a place that allows ease of use.
2. Keep your refrigerator away from heat sources, humid places and direct sunlight.
3. There must be appropriate air ventilation around your refrigerator in order to achieve an efficient operation.

If the refrigerator is to be placed in a recess in the wall, there must be at least 5 cm distance with the ceiling and at least 5 cm with the wall. If the floor is covered with a carpet, your product must be elevated 2.5 cm from the floor.

4. Place your refrigerator on an even floor surface to prevent jolts.
5. This appliance is equipped with 'Food Protector Technology' which ensures that at the advised setting [4 - four on the control] the frozen food in the freezer will not defrost even if the ambient temperature falls as low as -15 °C. So you may then install your appliance in a garage or an unheated room without having to worry about frozen food in the freezer being spoilt. However at low ambient temperatures mentioned above, fridge contents are likely to freeze, so check and consume food in the fridge accordingly. When the ambient temperature returns to normal, you may change the setting to suit your needs.

### WARNING:

When positioning the appliance ensure the supply cord is not trapped or damaged.

### WARNING:

Do not locate extension sockets or charging transformers/power supplies or Lithium-Iron battery operated products adjacent to the compressor as they could overheat.

## Transportation Instructions

1. The appliance should be transported only in a vertical upright position. The packing as supplied must be intact during transportation.
2. If during the course of transport the appliance has to be transported horizontally, it must only be laid on its right hand side when standing in the front of the appliance. After bringing it to upright position, it must not be operated for at least 4 hours to allow the system to settle.
3. Failure to comply with the above instructions could result in damage occurring to the appliance. The manufacturer will not be held responsible if these instructions are disregarded.
4. The appliance must be protected against rain, moisture and other atmospheric influences.
5. When positioning your appliance take care not to damage your flooring, pipes, wall coverings etc. Do not move the appliance by pulling by the door or handle.
6. Empty any water in the drain tray before moving. See section 'Defrosting' and 'Care & cleaning' for further information.
7. Make sure that the defrost water pipe at the back of the product is fixed to the plastic evaporating pan on the top of the compressor, to avoid defrost water spillage on the floor.
8. The appliance must be protected against rain, moisture and other atmospheric influences.

**Important: Care must be taken while cleaning / carrying the appliance to avoid touching the bottom of the condenser metal wires at the back of the appliance as you might injure your fingers and hands.**

**Important: This appliance is not designed for stacking with any other appliance. When positioning your appliance, take care not to damage your flooring, pipes, wall coverings etc.**

**Important:** Care must be taken while cleaning / carrying the appliance to avoid touching the bottom of the condenser metal wires at the back of the appliance as you might injure your fingers and hands.

Do not attempt to sit or stand on top of your appliance as it is not designed for such use. You could injure yourself or damage the appliance.

**Important:** Make sure that mains cable is not caught under the appliance during and after carrying / moving the appliance, to avoid the mains cable becoming cut or damaged. "Do not allow children to play with the appliance or tamper with the controls. **Blomberg** declines to accept any liability should the instructions not be followed.

## Installation Instructions

1. Fit the two plastic wall spacers supplied onto the condenser at the back of the appliance by rotating 1/4 turn.

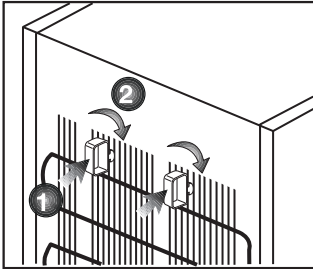

2. Locate the appliance on a smooth surface.

3. To ensure it is standing upright adjust the two front feet by turning clockwise or anti-clockwise, until it is in firm contact with the floor. Correct adjustment of feet avoids excessive vibration and noise.

4. A special receptacle is supplied to store the mains plug during transit. The receptacle is fixed at the back of the cabinet on the side of the compressor. Gently remove the plug from the receptacle. Never pull the mains cord, you may damage the

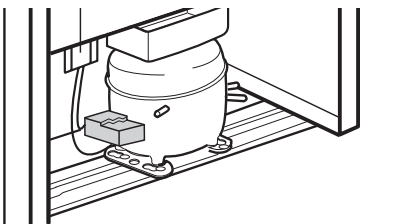
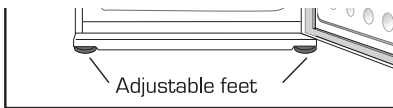

appliance. In case of transportation, ensure you locate the plug in the receptacle provided to avoid transit damage. I believe we should say somewhere that you can install in a garage or outhouse.

5. The space in the room where the appliance is installed must not be smaller than 10 cubic metres.

## Changing the illumination lamp

To change the Bulb/LED used for illumination of your refrigerator, call your Authorised Service.

The lamp(s) used in this appliance is not suitable for household room illumination. The intended purpose of this lamp is to assist the user to place foodstuffs in the refrigerator/freezer in a safe and comfortable way. The lamps used in this appliance have to withstand extreme physical conditions such as temperatures below  $-20^{\circ}\text{C}$ .

(only chest and upright freezer)

### WARNING:

Do not locate extension sockets or charging transformers/power supplies or Lithium-Iron battery operated products adjacent to the compressor as they could overheat.

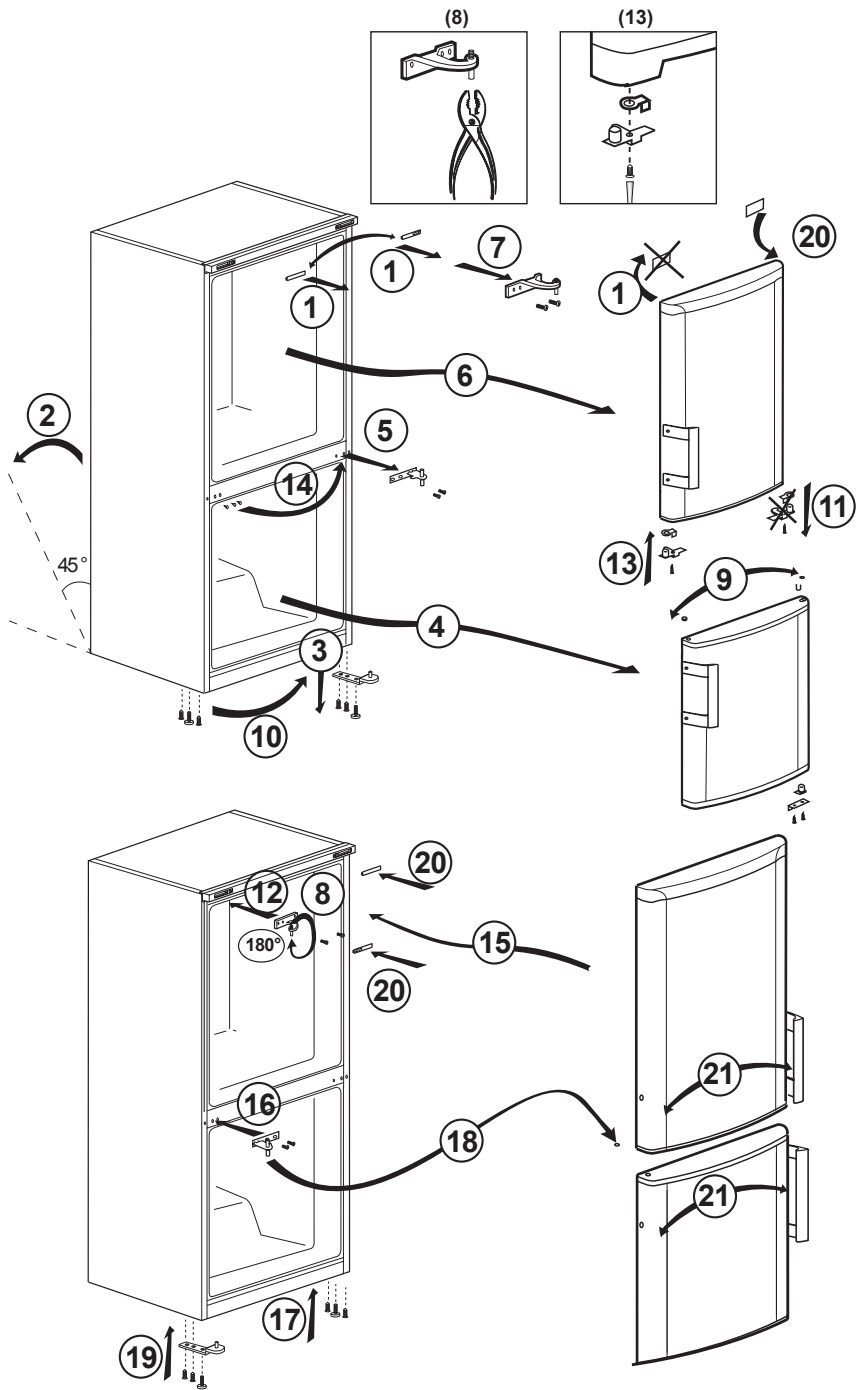

## 4 Before operating

---

### Final Check

Before you start using the fridge/freezer check that:

- 1.** The feet have been adjusted for perfect levelling.
- 2.** The interior is dry and air can circulate freely at the rear of the cabinet.
- 3.** Clean the interior as recommended under “CLEANING AND CARE.”
- 4.** Insert the plug into the wall socket and switch on the electricity supply.
- 5.** When the door is open the fridge interior light will come on.
- 6.** You will hear a noise as the compressor starts up. The liquid and gases sealed within the refrigeration system may also give rise to noise, whether the compressor is running or not which is quite normal. “Due to operation of the fan inside the frost free freezer compartment, overall noise level is slightly higher in comparison to non-frost free appliances. This is quite normal and is not a fault.”
- 7.** Set the setting knob half way between min and max.
- 8.** Front edges of the cabinet may feel warm. This is normal. These areas are designed to be warm to avoid condensation.
- 9.** “Do not load the appliance immediately it is switched on. Wait until the correct storage temperature has been reached. We recommend that you check the temperature with an accurate thermometer (see; Temperature Control and Adjustment)”

## 5 Using your refrigerator

### Temperature Control And Adjustment

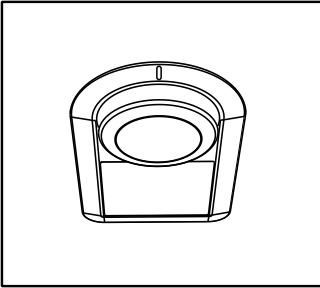

The operating temperature is regulated by the temperature control.

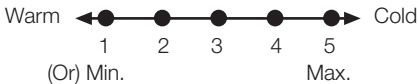

**1=Lowest cooling setting (Warmest setting).**

**5=Highest cooling setting (Coldest setting).**

The average temperature inside the fridge should be around +5°C.

Please choose the setting according to the desired temperature.

Please note that there will be different temperatures in the cooling area.

The coldest region is immediately above the vegetable compartment.

The interior temperature also depends on ambient temperature, the frequency with which the door is opened and the amount of foods kept inside.

Frequently opening the door causes the interior temperature to rise.

For this reason, it is recommended to close the door again as soon as possible after use.

### Thermostat setting button

The interior temperature of your refrigerator changes for the following reasons;

- Seasonal temperatures,
- Frequent opening of the door and leaving the door open for long periods,
- Food put into the refrigerator without cooling down to the room temperature,
- The location of the refrigerator in the room (e.g. exposing to sunlight).
- You may adjust the varying interior temperature due to such reasons by using the thermostat.
- If the ambient temperature is higher than 25°C, turn the thermostat button to maximum position.
- If the ambient temperature is lower than 25°C, turn the thermostat button to minimum position.



## Storing Frozen Food

Prepacked commercially frozen food should be stored in accordance with the frozen food manufacturer's instructions for a  frozen food storage compartment.

To ensure that the high quality achieved by the frozen food manufacturer and the food retailer is maintained, the following should be remembered:

1. Put packets in the freezer as quickly as possible after purchase.
2. Ensure that contents are labelled and dated.
3. Do not exceed "Use By", "Best Before" dates on the packaging. If there is a power failure do not open the door. Frozen food should not be affected if the failure lasts for less than 21 hrs. If the failure is longer, then the food should be checked and either eaten immediately or cooked and then re-frozen.

## Freezing Fresh Food

Please observe the following instructions to obtain the best results.

Do not freeze too large a quantity at any one time. The quality of the food is best preserved when it is frozen right through to the core as quickly as possible.

Do not exceed the freezing capacity of your appliance in 24 h which is 5 kg

Placing warm food into the freezer compartment causes the refrigeration compressor to operate continuously until the food is frozen solid. This can temporarily lead to excessive cooling of the refrigeration compartment.

When freezing fresh food turn the control toward MAX. Small quantities of food up to 1/2 kg. (1 lb) can be frozen without having to rotate the temperature control.

Install in room -15C to +32C .

You may place fresh food to be frozen in any part of the freezer.

Take special care not to mix already frozen food and fresh food.

## Making Ice Cubes

Fill the ice - cube tray 3/4 full with water and place it in the Ice Bank. Loosen frozen trays with the handle of a spoon, never use sharp edged objects such as knives, forks. Store ice-cubes in the Ice Bank.

Note: If freshly made ice cubes are not consumed for several weeks and stored in Ice Bank, they will slowly reduce in size and eventually disappear completely.

## Defrosting

### A) Fridge Compartment

The fridge compartment defrosts automatically. The defrosting water runs to the drain tube via a collection container at the back of the appliance (1). (see diagram) During defrosting water droplets may form at the back of the fridge compartment where concealed evaporator is located. Some droplets may remain on the liner and refreeze when defrosting is completed. Do not allow items in the fridge to touch the back wall as the water droplets will make them wet. Do not use pointed or sharp edged objects such as knives, forks to remove the droplets which have frozen.

If at any time the defrost water does not drain from the collection channel, check to ensure that no food particles have blocked the drain tube. The drain tube can be cleared by pushing the special plastic plunger provided down the drain tube (2). If the frost layer reaches about 1/4" (7 mm), reduce the setting (i.e. from 4 to 1) to restart automatic defrosting.

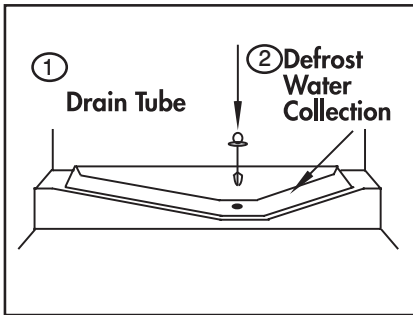

## B) Freezer Compartment

The freezer compartment defrosts automatically.

### Warnings!

- The fan inside the freezer compartment circulates cold air. Never insert any object through the guard. Do not allow children to play with the freezer fan.
- Never store products that contain inflammable propellant gas (eg dispensers, spray cans etc.) or explosive substances.
- Don't cover the shelves with any protective materials, which may obstruct air circulation.

- Do not allow children to play with the appliance or tamper with the controls.

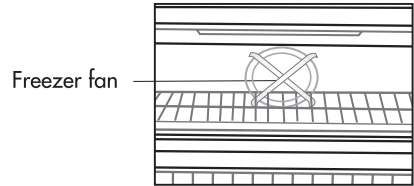

- Maximum frozen food storage volume is achieved without using the drawers and the upper shelf cover provided in the freezer compartment. Energy consumption of your appliance is declared while the freezer compartment is fully loaded on shelves without the use of the drawers and upper shelf cover. Use the given wire shelf at the bottom of the freezer compartment for a better energy consumption performance.
- It is recommended that you place foodstuffs on top shelf of freezer for initial freezing.

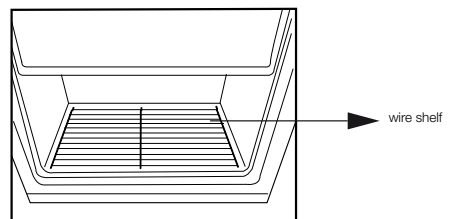

## **Chiller Compartment**

By the help of 0 °C compartment you can keep your meat, fish and wrapped food 2-3 times longer than a standard fridge compartment.

Air inside this compartment is drier than other zones.

The average temperature inside this compartment is around 0 °C.

Do not store fruits and vegetables in this compartment.

## 6 Maintenance and cleaning

---

- We recommend that you switch off the appliance at the socket outlet and pull out the mains plug before cleaning.
  - Never use any sharp abrasive instrument, soap, household cleaner, detergent and wax polish for cleaning.
  - Use luke warm water to clean the cabinet of the appliance and wipe it dry.
  - Use a damp cloth wrung out in a solution of one teaspoon of bicarbonate of soda to one pint of water to clean the interior and wipe it dry.
  - Make sure that no water enters the lamp housing.
  - If the appliance is not going to be used for a long period of time switch it off, remove all food, clean it and leave the door ajar.
  - Any dust that gathers on the condenser, which is located at the back of the appliance, should be removed once a year with a vacuum cleaner.
  - Check door seals regularly to ensure they are clean and free from food particles.
  - Removal of door tray
  - To remove door racks, remove all the contents and then simply push the door rack upwards from the base.
  - To remove a freezer drawer, pull it as far as possible, and then tilt it upwards, and then pull it out completely.
  - To remove the freezer flap door, first open the door 3" and then gently pull it off. Make sure that the flap is in place before closing the freezer door.
  - Make sure that the special plastic container (drain tray) at the back of the appliance which collects defrost water is clean at all times. If you want to remove the tray to clean it follow the instructions below :
  - Switch off at the socket outlet and pull out the mains plug.
  - Push the lug down with the tip of a screw driver & pull out with a jerk movement
  - Clean the drain tray and wipe it dry.
  - Reassemble reversing the sequence and operations.
  - Avoid spillage of food particularly small items like rice, peas, beans through the fan guard as they may cause the cooling system to block and therefore operate less efficiently.
- ⚠ Never use cleaning agents or water that contain chlorine to clean the outer surfaces and chromium coated parts of the product. Chlorine causes corrosion on such metal surfaces.

## 7 Do's and Don'ts

---

- Do- Clean your appliance regularly (See “Cleaning and Care”)
- Do- Keep raw meat and poultry below cooked food and dairy products.
- Do- Take off any unusable leaves on vegetables and wipe off any soil.
- Do- Leave lettuce, cabbage, parsley and cauliflower on the stem.
- Do- Wrap cheese firstly in greaseproof paper and then in a polythene bag excluding as much air as possible. For best results take out of the fridge compartment an hour before eating.
- Do- Wrap raw meat and poultry loosely in polythene or aluminium foil. This prevents drying.
- Do- Wrap fish and offal in polythene bags.
- Do- Wrap food which have a strong odour or can dry out in polythene bags, aluminium foil or place in an airtight container.
- Do- Wrap bread well to keep it fresh.
- Do- Chill white wines, beer, lager and mineral water before serving.
- Do- Check contents of the freezer every so often.
- Do- Keep food for as short a time as possible and adhere to “Best Before”, “Use by” etc. dates.
- Do- Store commercially frozen food in accordance with the instructions given on the packets that you buy.
- Do- Always choose high quality fresh food and be sure it is thoroughly clean before you freeze it.
- Do- Prepare fresh food for freezing in small portions to ensure rapid freezing.
- Do- Wrap all food in aluminium foil or freezer quality polythene bags and make sure any air is excluded.
- Do- Wrap frozen food when you buy it and put it in to the freezer as soon as possible.
- Do- Defrost food in the fridge compartment.
- Do- Remove ice cream from the freezer 10-20 minutes before serving.
- Don't- Store bananas in your fridge compartment.
- Don't- Store melon in your fridge. It can be chilled for short periods as long as it is wrapped to avoid it flavouring other food.
- Don't- Store poisonous or any dangerous substances in your appliance. It has been designed for the storage of edible foodstuffs only.
- Don't- Consume food which has been stored for an excessive time in the fridge.
- Don't- Store cooked and fresh food together in the same container. They should be packaged and stored separately.
- Don't- Let defrosting food or food juices drip onto food.
- Don't- Leave the door open for long periods as this will make the appliance more costly to run and cause excessive ice formation.
- Don't- Put hot food into the appliance. Let it cool down first.
- Don't- Put liquid-filled bottles or sealed cans containing carbonated liquids into the freezer as they may burst.
- Don't- Exceed the maximum freezing loads (5 kg in any 24 hours) when freezing fresh food.
- Don't- Give children ice-cream and water ices direct from the freezer. The low temperature may cause ‘freezer burns’ on lips.

Don't- Freeze fizzy drinks.

Don't- Try to keep frozen food which has thawed, it should be eaten within 24 hours or cooked and refrozen.

Don't- Remove items from the freezer with wet hands.

Don't- Close the freezer door before placing the compartment cover in its place.

Don't- Leave frozen food at room temperature to thaw; the best way to defrost food is to put it in the fridge to thaw slowly. Make sure you avoid defrosting food or food juices drip onto other food.

## Problem Solving

If the appliance does not operate when switched on, check whether:

- The plug is inserted properly in the socket and that the power supply is on. (To check the power supply to the socket, plug in another appliance)
- The fuse has blown/circuit breaker has tripped/main distribution switch has been turned off.
- The temperature control has been set correctly and not to "0" (OFF)
- New plug is wired correctly if you have changed the fitted moulded plug.

If the appliance is still not operating after the above checks, please refer to the section on "How To Obtain Service".

Please ensure that above checks have been made as a charge will be made if no fault is found.

## 8 Guarantee Details

---

### Guarantee Details

Your new Blomberg product is guaranteed against faulty materials, defective components or manufacturing defects. The guarantee starts from the date of original purchase of the product for a period of three (3) years, unless Beko plc (the “Manufacturer”) agrees to extend the guarantee for the product in writing. If you have any questions about the guarantee on your product (including how long it is valid), please contact your retailer or our Call Centre on 0333 207 9870.

This guarantee does not in any way diminish or affect your statutory rights in connection with the product. This guarantee is in addition to your statutory rights as a consumer. If you have any questions about these rights, please contact the retailer from which you purchased the product. In certain circumstances, it is possible that your statutory rights may offer additional or higher levels of protection than those offered under the terms of this guarantee.

### What is covered by this guarantee?

- Repairs to the product required as a result of faulty materials, defective components or manufacturing defects.
- Functional replacement parts to repair a product.
- The costs of a Blomberg Approved Engineer to carry out the repair.

### What is not covered?

- Transit and delivery damage.
- Cabinet or appearance parts, including but not limited to control knobs, flaps and handles.
- Accessories and/or consumable items including but not limited to ice trays, scrapers, cutlery baskets, filters and light bulbs.
- Repairs necessary as a direct or indirect result of:
  - Accidental damage, misuse or abuse of a product.
  - An attempted repair of a product by anyone other than a Blomberg Approved Engineer (the “Engineer”).
  - Installation or use of a product where such installation or use fails to meet the requirements contained in this guarantee or the User Instructions Booklet.
- Repairs to a product operated at any time on commercial or non-residential household premises (unless we have previously agreed to the installation environment).

This guarantee is limited to the cost of repairing the product. To the extent permitted by law, Beko plc (the “Manufacturer”) does not accept and will not be held liable for any financial loss incurred in connection with the failure of any product to operate in accordance with the expected standards. Such financial loss includes but is not limited to loss arising from:

- Time taken off work.
- Damaged food, clothing or other items.
- Meals taken at restaurants or from takeaways.
- General compensation for inconvenience.

## **Important Notes**

- Your product is designed and built for domestic household use only.
- The guarantee will automatically be void if the product is installed or is used in commercial or non-residential domestic household premises, unless we have previously agreed to the installation environment.
- The product must be correctly installed, located and operated in accordance with the instructions contained in the User Instructions Booklet provided with your product.
- Professional installation by a qualified Electrical Domestic Appliance Installer is recommended for all Washing Machines, Dishwashers and Electric Cookers (as incorrect installation may result in you having to pay for the cost of repairing the product).
- Gas Cookers must be professionally installed by a Gas Safe (or Gas Networks Ireland for Republic of Ireland) registered gas installer.
- This guarantee is given in respect of products purchased and used within the United Kingdom and the Republic of Ireland.
- This guarantee is effective from the initial date of purchase of a new product from an authorised retailer and will be void if the product is resold.
- This guarantee does not apply to graded sales (where the product is purchased as a “second”).
- Possession of a copy of these terms and conditions does not necessarily mean that a product has the benefit of this guarantee. If you have any questions, please call our Call Centre on the number set out above.
- The Manufacturer reserves the right to terminate the guarantee if its staff or representatives are subjected to physical or verbal abuse in the course of carrying out their duties.
- Optional extras, where available (i.e. extendable feet) are supplied on a chargeable basis only.



## **Does Blomberg offer replacements?**

This is a repair-only guarantee. On occasion the Manufacturer may at its sole discretion, replace your product with a new product instead of carrying out a repair. Where a replacement is offered, this would normally be an identical model, but when this is not possible, a model of similar specification will be provided. The Manufacturer will cover the costs and arrange for the delivery of the new product and for the return of the old product. Any costs related to disconnecting the faulty product and installing the replacement product will not be borne by the Manufacturer unless previously agreed to in writing. The original guarantee will continue to apply to the replacement product; the new product will not come with a new guarantee.

## **When will the repair take place?**

Our engineers work Monday to Friday 9.00am to 5.00pm. Appointments outside these hours may be possible at the sole discretion of the Manufacturer but cannot be guaranteed. Whilst our Engineers will endeavour to minimize inconvenience and to meet requests for specific timed appointments, this cannot be guaranteed. The Manufacturer will not be liable for delays or if it is unable to carry out a repair because a convenient appointment cannot be arranged.

## **Will there be any charge for the repairs?**

It is your responsibility to provide evidence to the Engineer that your product is covered by this guarantee with a proof of purchase. The Manufacturer reserves the right to charge for the reasonable cost of any service call if:

- You cannot provide evidence that your product is covered by this guarantee.
- Where a service call has been made and the engineer finds that there is no fault with your product.
- That your product has not been installed or operated in accordance with the User Instructions Booklet.
- That the fault was caused by something other than faulty materials, defective components or manufacturing defects.
- For missed appointments.

Payment of these costs are due immediately upon the Engineer providing you with an invoice. If you fail to pay the costs for the service call in a timely manner, the Manufacturer reserves the right to terminate the guarantee.

If you are a resident of the United Kingdom, this guarantee will be governed by English law and subject to the English Courts, save where you live in another part of the United Kingdom, in which case the law and courts of that location will apply.

If you are resident in the Republic of Ireland, this guarantee will be governed by Irish law and the Irish courts will have jurisdiction.

### **How To Obtain Service**

Please keep your purchase receipt or other proof of purchase in a safe place; you will need to have it should the product require attention under guarantee.

It will be useful if you complete the details below, as it will help us assist you when requesting service. (The model number is printed on the Instruction Booklet and the serial number is printed on the Rating Label affixed to the appliance). Recording of these details alone will not count as proof of purchase. A valid proof of purchase is required for under guarantee service.

The area around the product must be easily accessible to the Engineer without the need for cabinets or furniture being removed.

It is your responsibility to ensure our Engineers have a clean and safe environment to carry out any repairs.

.....  
**Model No:**

**Serial No:**

**Retailer:**

**Date of purchase:**

.....  
**For service under guarantee simply telephone the appropriate number below**

**UK Mainland & Northern Ireland:** 0333 207 9870.

**Republic of Ireland:** 01 691 0160

**Register your appliance at** [www.blomberguk.com/register](http://www.blomberguk.com/register)

Before requesting service please check the troubleshooting guide in the Operating Instructions as a charge may be levied where no fault is found even though your product may still be under guarantee.

### **Service once the manufacturers guarantee has expired**

If you have purchased an extended guarantee please refer to the instructions contained within the extended guarantee agreement document, otherwise please call the appropriate number above where service can be obtained at a charge.

Should you experience any difficulty in obtaining service contact the Blomberg Customer Helpline on Tel: 0333 207 9870 or  
e-mail: [customerservice@support.Blomberguk.com](mailto:customerservice@support.Blomberguk.com)

.....  
This guarantee is provided by Beko plc. Beko House, 1 Greenhill Crescent, Watford, Herts, WD18 8QU. Beko plc is registered in England and Wales with company registration number 02415578.

**Blomberg<sup>®</sup>**

**seit 1883**

[www.blomberginternational.com](http://www.blomberginternational.com)

[info@blomberginternational.com](mailto:info@blomberginternational.com)